



# TPS

## Thyristor Power System 8-1500A, 230-690V



## Instruction Manual

Ver. 03 March 2009

# TPS Instruction Manual

## 1. TABLE OF CONTENT

1.	<b>Table of content</b> .....	<b>2</b>
2.	<b>Safety &amp; Warnings</b> .....	<b>3</b>
2.1	Safety .....	3
2.2	Attention .....	3
2.3	Warnings .....	3
3.	<b>Technical Data</b> .....	<b>4</b>
3.1	Introduction .....	4
3.2	Rating, Frames sizes and Weights .....	4
3.3	TPS Selection .....	4
3.4	Mains and control description .....	5
3.5	Input/Output indication .....	7
3.6	Load Connections .....	7
3.7	Modes of operation .....	7
3.7.1	Zero Crossing .....	7
3.7.2	Phase Control .....	8
3.7.3	Phase control to zero crossing (Soft start) .....	8
3.7.4	Phase Control-Power .....	8
3.8	Synchronized mode .....	9
4.	<b>Recommended Wiring Scheme</b> .....	<b>10</b>
4.1	Load connection schemes .....	10
4.2	INSIDE DELTA Wiring .....	11
4.3	Typical control scheme .....	11
4.4	Communication and Synchronization wiring .....	12
4.5	Wiring Notes .....	12
4.5.1	Short Circuit Protection .....	13
4.5.2	Transient Protection .....	13
5.	<b>Dimensions</b> .....	<b>13</b>
6.	<b>Installation</b> .....	<b>17</b>
6.1	Prior to Installation .....	17
6.2	Mounting .....	17
6.3	Temperature range & heat dissipation .....	17
6.4	Jumpers settings for analogue input configuration .....	18
6.5	Dip switches settings for analogue output optional PCB .....	18
7.	<b>Control Keypad</b> .....	<b>20</b>
7.1	LCD Arrangement .....	20
7.2	Push-buttons .....	20
7.3	Status LEDs .....	21
7.4	Reviewing and modifying parameters .....	21
7.5	Special actions performed by the key-pad .....	21
7.5.1	Run self test, Software version, default parameters and clear statistical data .....	21
7.6	Mode Pages .....	22
7.7	Mode Pages, parameters & default values .....	23
7.7.1	Main parameters settings – page 1 .....	25
7.7.2	I/O Parameters – page 2 .....	27
7.7.3	Protection Parameters – page 3 .....	29
7.7.4	Load shedding parameters settings– page 4 .....	31
7.7.5	Tripping/alarm parameters – page 5 .....	32
7.7.6	Comm. Parameters – page 8 .....	33
7.7.7	Actual data – page 9 .....	34
7.7.8	Statistical data – page 10 .....	35
7.7.9	Fault data – page 11 .....	35

8.	<b>TROUBLE SHOOTING</b> .....	<b>36</b>
8.1	Warranty Claim and Fault Inquiry .....	38
9.	<b>TECHNICAL SPECIFICATIONS</b> .....	<b>39</b>
10.	<b>ordering information</b> .....	<b>40</b>

## 2. SAFETY & WARNINGS

### 2.1 Safety

	1	Read this manual carefully before operating the equipment and follow its instructions.
	2	Installation, operation and maintenance should be in strict accordance with this manual, national codes and good practice.
	3	Installation or operation not performed in strict accordance with these instructions will void manufacturer warranty.
	4	Disconnect all power inputs before servicing the TPS and/or the load.
	5	After installation, check and verify that no parts (bolts, washers, etc) have fallen into the TPS.

### 2.2 Attention

	1	This product was designed for compliance with IEC 947-4-2 for class A equipment.
	2	Use of the product in domestic environments may cause radio interference, in which case, the user may be required to employ additional mitigation methods.
	3	Utilization category is AC-53a or AC53b, Form 1. For further information, see Technical Specification

### 2.3 Warnings

	1	Internal components and PCBs are at mains potential when the TPS is connected to mains. This voltage is extremely dangerous and will cause death or severe injury if contacted.
	2	When TPS is connected to mains, even if control voltage is disconnected, full voltage may appear on its output.
	3	The TPS must be grounded to ensure correct operation, safety and to prevent damage.
	4	Check that Power Factor capacitors are not connected to the output side of the soft TPS.
	5	Do not interchange line and load connections
	6	Phase Control Firing, may cause Radio interferences, in which case the user may be required to employ additional mitigation methods.

The company reserves the right to make any improvements or modifications to its products without prior notice.

### 3. TECHNICAL DATA

#### 3.1 Introduction

Solcons' Thyristor based Power System (TPS) is a heavy duty fully digital, Zero-crossing, Phase Control or Phase Control-Power, three phase control power unit for all types of Resistive/Inductive loads (temperature control of heaters, etc.).

Providing a wide range 8-1500A, 230-690V, 50/60Hz, it can be installed in a variety of heating systems. Control of output voltage can be done by input signal of 0-10VDC, 4-20mA, 0-20mA, by a potentiometer (Optional) or via communication (Optional) for precision temperature control.

A special optional digital synchronization system enables load sharing and prevents excessive loading in multi controller applications.

Fully programmable with 9 protection functions, including "Load Unbalance" alarm to detect a faulty element, even in parallel connected element system and "Under power level" alarm to detect faulty element in case the system is designed to work unbalanced.

Two line, 16 character LCD display is used for the TPS programming, actual values, statistical & maintenance data.

#### **Options:**

- Potentiometer input for control. (Without the need for external power supply)
- Multi TPS synchronization system for load shedding
- RS-485 communication for TPS programming, remote data readings and controlling.
- Analogue output PCB (4-20mA, 0-20mA or 0-10V).

#### 3.2 Rating, Frames sizes and Weights

TPS type	RATED CURRENT [A]	Dimensions WxHxD [mm]	Weight [Kg]
TPS 8	8	172x291x185	6.3
TPS 17	17	172x291x185	6.3
TPS 31	31	172x291x185	6.4
TPS 44	44	172x291x185	6.5
TPS 58	58	172x291x185	6.5
TPS 72	72	172x291x185	6.5
TPS 85	85	172x390x195	8.5
TPS 105	105	172x390x195	8.5
TPS 145	145	274x385x238	14.5
TPS 170	170	274x385x238	14.5
TPS 210	210	274x385x238	14.5
TPS 310	310	380x455x292	31
TPS 390	390	380x455x292	31
TPS 460	460	380x555x292	51
TPS 580	580	470x640x302	53
TPS 820	820	470x640x302	53
TPS 950	950	Consult factory	
TPS 1100	1100	Consult factory	
TPS 1500	1500	Consult factory	

Please note that the company reserves the right to make any improvements or modifications to its products without prior notice!  
Refer to section 5 page 13 for detailed dimensional drawings.

#### 3.3 TPS Selection

Select the TPS according to LOAD RATED CURRENT(FLA) - as indicated on its nameplate.

#### **Note:**

TPS withdrawn current by the load must not exceed TPS RATED CURRENT in each and every phase of the TPS!

## 3.4 Mains and control description

Indication	Description	Remarks
L1, L2, L3	Connection to mains voltage up to 690V.	Three Main Voltage levels are available: 400V (230-400V), 480V, 600V and 690V. <b>Note:</b> 400V applies for 230 to 400V.
U, V, W	Connection to resistive/inductive load.	Load connection must be programmed to TPS. Refer to section 3.6 page 7.
G	Connection to Ground.	
Terminal 1	Control phase (Positive – for DC control)	Three control voltages are available: 115VAC (50/60Hz), 230VAC (50/60Hz), 110VDC.
Terminal 3	Control Neutral (Return)	
Terminal 4	Input – RUN command.	
Terminal 5	Input - Auxiliary programmable input.	Auxiliary Input can be programmed as one of the options: SYNC. AUTHORIZED KEY REMOTE RESET N.C. EXT. FAULT N.O. EXT. FAULT N.C. INTERLOCK N.O. INTERLOCK Refer to section 7.7.2 page 27.
Terminal 6	Common.	This terminal is a reference to terminals 4 & 5.
Terminal 7	Programmable output relay A – Common.	Any of the output relays A, B or C can be programmed to one of the following functions: Run, Alarm, Alarm fail safe, Trip, Trip fail safe, Tripping/Alarm (Any fault programmed in the tripping and alarm options will energize the relay.) Refer to section 7.7.2 page 27 for programming output relays.
Terminal 8	Programmable output relay A – Normally open (NO).	
Terminal 9	Programmable output relay A – Normally closed (NC).	
Terminal 10	Programmable output relay B – Common.	
Terminal 11	Programmable output relay B – Normally open (NO).	
Terminal 12	Programmable output relay B – Normally closed (NC).	
Terminal 13	Programmable output relay C – Common.	
Terminal 14	Programmable output relay C – Normally open (NO).	
Terminal 15	Programmable output relay C – Normally closed (NC).	

Indication	Description	Remarks
Terminal 16	Analogue input signal (+)	Terminals 16 & 17 are used for both, 0-10V and 4-20mA, 0-20mA analogue signals. Terminals 16, 17 are used also when potentiometer option is installed. Refer to section 7.7.2 page 27 for analogue input programming. <b>Notes:</b> Set internal jumper on the main control board for the selected analogue input signal. Refer to section 6.4 page 18. When the TPS is programmed to get its analog input via communication, these inputs are not operative. Refer to section 7.7.6 page 33. <b>Caution</b> Damage may occur if jumpers are not properly set (see instructions for JP1, JP2, JP3 & JP4). Jumpers are factory set for 4-20mA input.
Terminal 17	Analogue input signal (-)	
Terminal 18	Synchronization signal (+) (Optional)	Sync. signal use Shielded twisted pair, for daisy chaining. Up to 10 TPS units can be connected for master slave configuration. Master Slave configuration is designed for units located in the vicinity of 20 meter maximum. Refer to section 3.8 page 9.
Terminal 19	Synchronization signal (-) (Optional)	
Terminal 20	POT. CW - Output voltage for potentiometer connection (Only when option "P" is present.) (Optional).	When option "P" is present connect potentiometer CW to terminal 20, potentiometer slide to terminal 16 and potentiometer CCW to terminal 17. For potentiometer input control refer to section 6.4 page 18 for jumper settings and program TPS input to "Voltage input – Refer to section 7.7.2 page 27 for analogue input programming. <b>Notes:</b> A potentiometer of 10kOhm must be used! Use a high precision potentiometer for better resolution. When the TPS is programmed to get its analog input via communication, these inputs are not operative. Refer to section 7.7.6 page 33.
Terminal 21	Not connected	
Terminal 22	Comm. Ground (Optional)	Communication use Shielded twisted pair, for daisy chaining. Up to 32 units can be connected for Modbus RS485 communication. For reliable communication, units should be installed in the vicinity of 200m maximum, from the first to the last unit.
Terminal 23	RS-485 Communication (-) (Optional)	
Terminal 24	RS-485 Communication (+) (Optional)	
(+) OUT	Analogue output (+)(Optional)	This output is used when analogue output option is installed. Analogue output can be

Indication	Description	Remarks
(-) OUT	Analogue output (-)(Optional)	<p>configured as 4-20mA, 0-20mA or 0-10V. Refer to section 6.5 page 18 for hardware settings.</p> <p>Analogue output can be programmed as a signal proportional to output power or average of 3 phase currents or I1 or I2 or I3 or as a reflection of the analogue input to the TPS.</p> <p>Refer to section 7.7.2 page 27 for programming analogue output.</p>

### 3.5 Input/Output indication

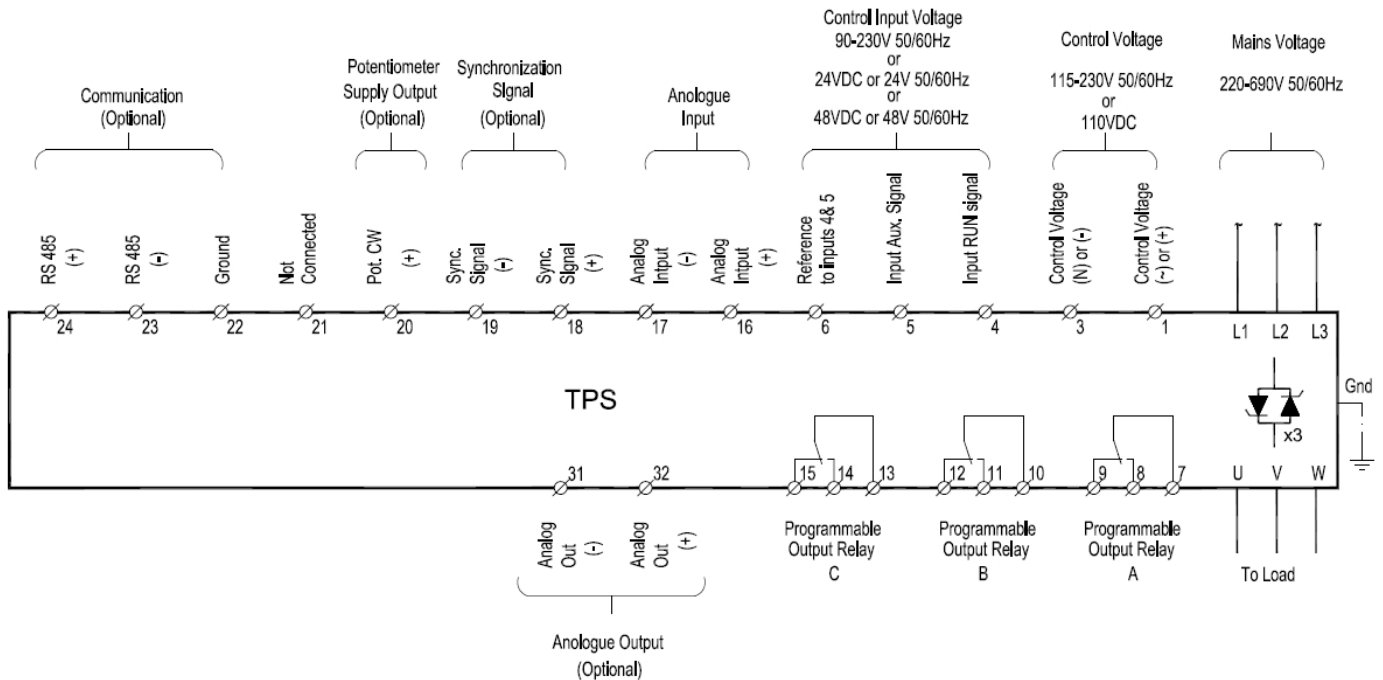

### 3.6 Load Connections

The TPS can be connect the load as shown in section 4.1 on page 10. The available configurations are: Wye with Neutral Connected, Wye with Neutral not Connected, Delta or inside Delta. Load connection type must be programmed to TPS. Refer to section 7.7.1 page 25.

#### **Note:**

Any number of parallel branches may be connected in the shown connection types provided that the total connected load will not exceed the current rating of the TPS unit.

### 3.7 Modes of operation

#### 3.7.1 Zero Crossing

In this mode of operation thyristor's firing is performed so that current starts at its zero crossing point .

Main advantages of this mode are:

- Minimizing RFI noise.
- Minimizing current THD.

Main disadvantages are:

- No "Soft start".
- High inrush current in case of load with temperature dependant characteristic (lower resistance when cold)
- Current may vary in time.

In this mode of operation the TPS is programmed to operate in a cycle. (Tct)

When, during this cycle, analogue input is set to maximum – The TPS will conduct continuously.

When analogue input is lower, a proportional number of waves will be delivered to the load during Tct.

Firing method must be programmed to TPS. Refer to section 7.7.1 page 25.

**Note:**

**Tct** = 1-10Sec.  
 (Adjustable in 0.1 sec steps)  
**Ton** = 2 cycles – Tct  
 Seconds (Minimum conducting time is 2 cycles)

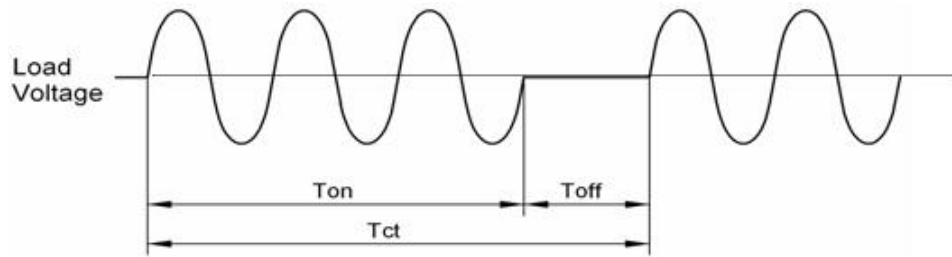

### 3.7.2 Phase Control

In this mode of operation thyristor's firing is performed in every half cycle proportional to the analogue input. Maximum analogue input will cause a full wave to load. When analogue input is lower, a proportional part of the sine wave will be delivered to the load.

Main advantages of this mode are:

- Enables "Soft start"
- Current variations are limited.

Main disadvantages are:

- Relatively high RFI noise.
- Relatively high current THD.

**Note:**

When load is connected in WYE NEUTRAL NOT CONNECTED or in LINE DELTA (both connections are without a neutral point) AND TPS is in PHASE CONTROL it is impossible to go to zero output. Minimum possible firing for such case gives 10-20% of output voltage. This is since in this case the firing of each phase depends on the three phases mains and we cannot control each phase voltage down to zero. In this case, zero input in analogue input causes the minimum possible voltage to appear in the output. Then, upon increasing the analogue input voltage, output voltage/current is monotonically increased.

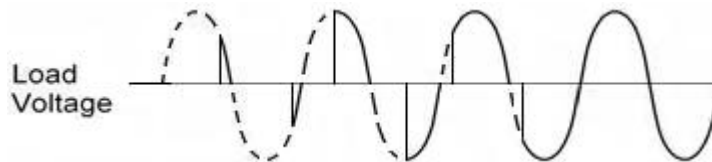

Firing method must be programmed to TPS. Refer to section 7.7.1 page 25.

### 3.7.3 Phase control to zero crossing (Soft start)

The user can program a time of which the TPS will function in PHASE CONTROL and then change to ZERO CROSSING mode.

This mode of operation (together with ANALOG IN T. CONST – refer to section 7.7.2 page 27) allows soft starting of the load. This mode is mostly used when load resistance has a temperature dependant characteristic (lower resistance when cold).

For soft stating the load, program the ANALOG IN T. CONST to a value from 0-10 seconds.

Program PHASE CONTROL TO ZERO CROSSING time to a value from 1-60 seconds.

When starting the TPS, even if analogue input is high, the ANALOG IN T. CONST function will gradually increase the "internal" value of the analogue input while TPS will function in PHASE CONTROL mode for the first 1-60 seconds (As programmed).

The outcome of this process will be a small current withdraw from the supply and slow heating of the heat element thus increasing its resistance and lowering the current.

For programming ANALOG IN T. CONST – refer to section 7.7.2 page 27.

Firing method must be programmed to TPS. Refer to section 7.7.1 page 25.

### 3.7.4 Phase Control-Power

In this mode of operation TPS function in PHASE CONTROL (See explanations above).

In PHASE CONTROL-POWER the output power of the TPS will be kept linear to the analogue input of the TPS.

Firing method must be programmed to TPS. Refer to section 7.7.1 page 25.

### 3.8 Synchronized mode

This mode of operation is applicable only if mode of operation is set to ZERO CROSSING. In this mode of operation the TPS Sync. Terminals should be wired in “daisy chain” as shown in section 4.4 on page 12. This mode is used to time share the ON time (Ton) period between the units. In this mode, the beginning of the ON cycles of the connected TPSs is equally shifted.

For example:

No. of TPS units – 3

Cycle time when TPS is in ZERO CROSSING (Tct – see section 3.7.1 page 7) – 3 seconds.

In this example TPS#1 will be set to master and TPS#2, TPS#3 will be set to slave.

When system is started, TPS#1 will go to ON first, TPS#2 will go to ON after 1 second (3 seconds/3), TPS#3 will go to ON after 2 seconds.

So, if the required duty cycle (Ton/Tct) is less than 1/3, one TPS only can be in ON state.

The Master is transmitting a “Sync” signal, received by all connected TPSs (Sync group members).

Only one unit of the group should be set as Master. All others should be set as slaves.

Refer to section 7.7.4 page 31 for programming.

#### **Notes:**

1. Sync. LED will lit once function is enabled.
2. In order to have a full number of ON cycles it is recommended to program the ON-OFF CYCLE time in such manner that the number of cycles (50 or 60 Hz) divided by the number of connected TPS units will be an integer. i.e. if 3 TPS units are connected with 50Hz mains, the ON-OFF time can be, for example, 0.9Sec (45 cycles), 1.2 Sec (60 cycles), 3Sec (150 cycles).
3. Synchronized mode can not be implemented if one current analog input is connected to several TPS units in series.

4. RECOMMENDED WIRING SCHEME

4.1 Load connection schemes

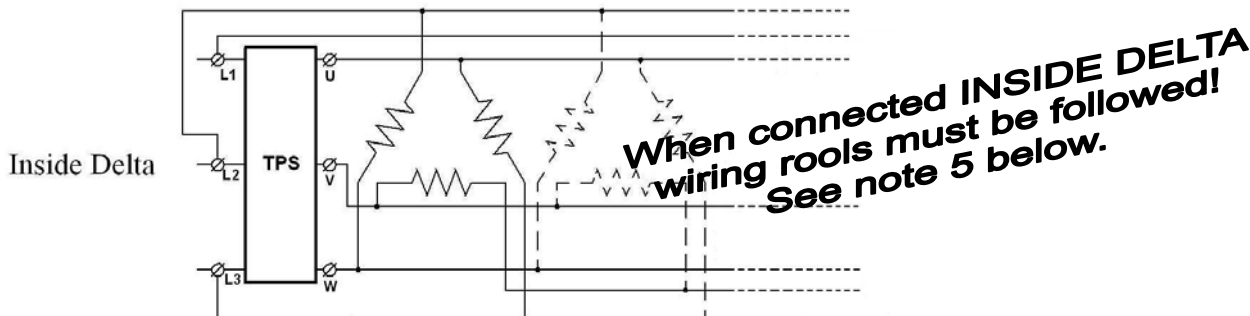
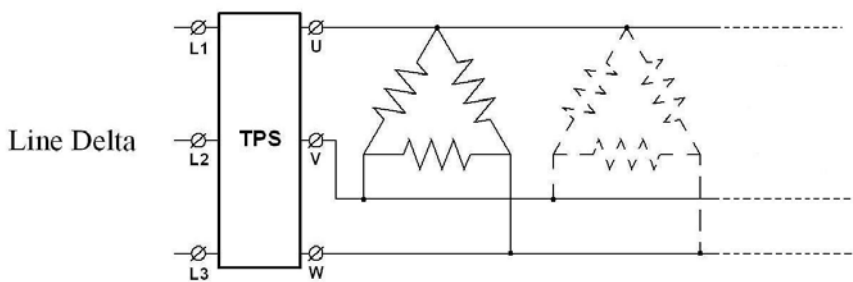
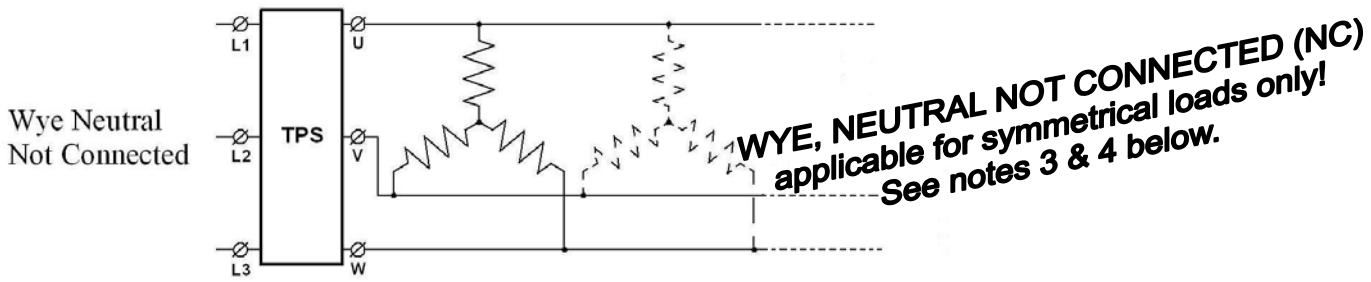
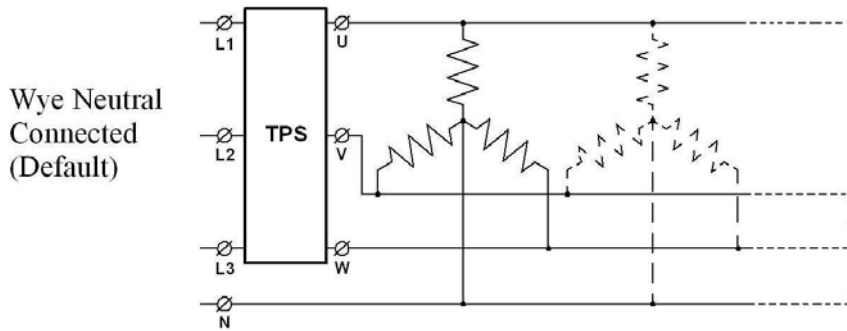

**Notes:**

- (1) – Set connection type to TPS. Refer to section 7.7.1 on page 25
- (2) When load is connected in WYE NEUTRAL NOT CONNECTED or in LINE DELTA (both connections are without a neutral point) AND TPS is in PHASE CONTROL it is impossible to go to zero output.  
Minimum possible firing for such case gives 10-20% of output voltage. This is since in this case the firing of each phase depends on the three phases mains and we cannot control each phase voltage down to zero.  
In this case, zero input in analogue input causes the minimum possible voltage to appear in the output. Then, upon increasing the analogue input voltage, output voltage/current is monotonically increased.
- (3) WYE, NEUTRAL NOT CONNECTED (NC) applicable for symmetrical loads only.  
Connecting to non symmetrical loads might damage the load!
- (4) When WYE, NEUTRAL NOT CONNECTED (NC) applies set the UNBALANCE protection to the lowest practical value and trip the TPS upon UNBALANCE or else load will damage.  
Refer to section 7.7.3 on page 29.
- (5) Refer to section 4.2 next page for INSIDE DELTA wiring instructions.

### 4.2 INSIDE DELTA Wiring

When the TPS is connected INSIDE DELTA wiring must be exactly as in the following diagram:

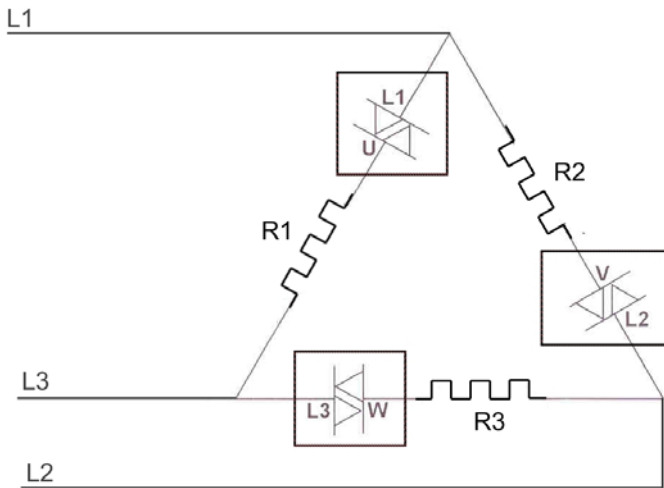

L1-U, L2-V, L3-W represent the three controlled TPS phases.

R1, R2 R3 represent the load.

L1, L2, L3 are mains voltage.

**Verify the following:**

- Phase sequence as below:

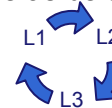

- Phase L1-U of the TPS is connected between L1 and L3 of the mains.
- Phase L2-V of the TPS is connected between L1 and L2 of the mains.
- Phase L3-W of the TPS is connected between L2 and L3 of the mains.

### 4.3 Typical control scheme

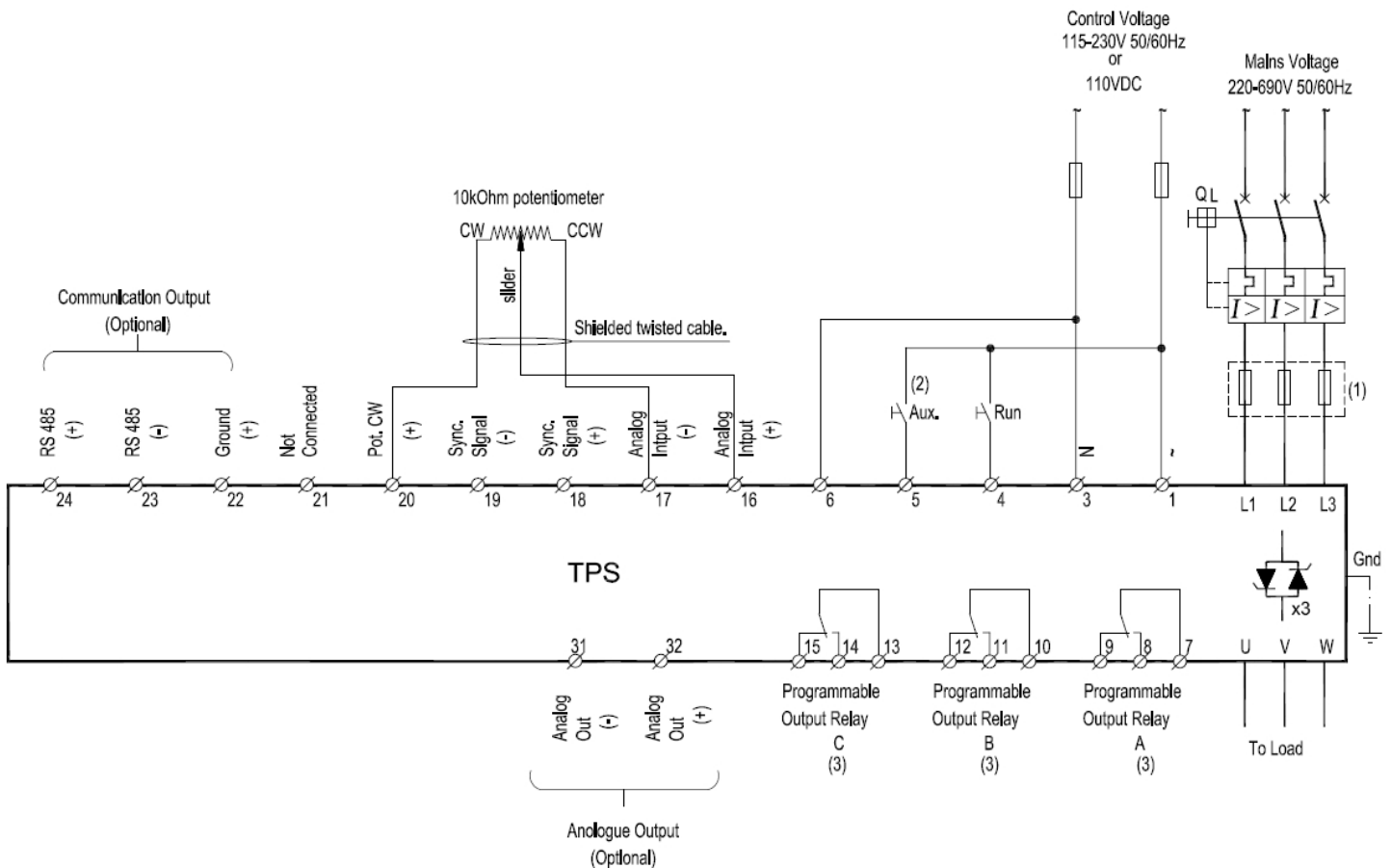

**Notes:**

- (1) - Use fuses for thyristors short circuit protection. Refer to section 4.5.1 on page 13
- (2) - For Aux. input programming refer to section 7.7.2 on page 27.
- (3) - For programmable output relays A, B & C refer to section 7.7.2 on page 27.
- (4) - When emergency Stop switch is required it is recommended to trip a series contactor or the feeding circuit breaker. (Not shown)

#### 4.4 Communication and Synchronization wiring

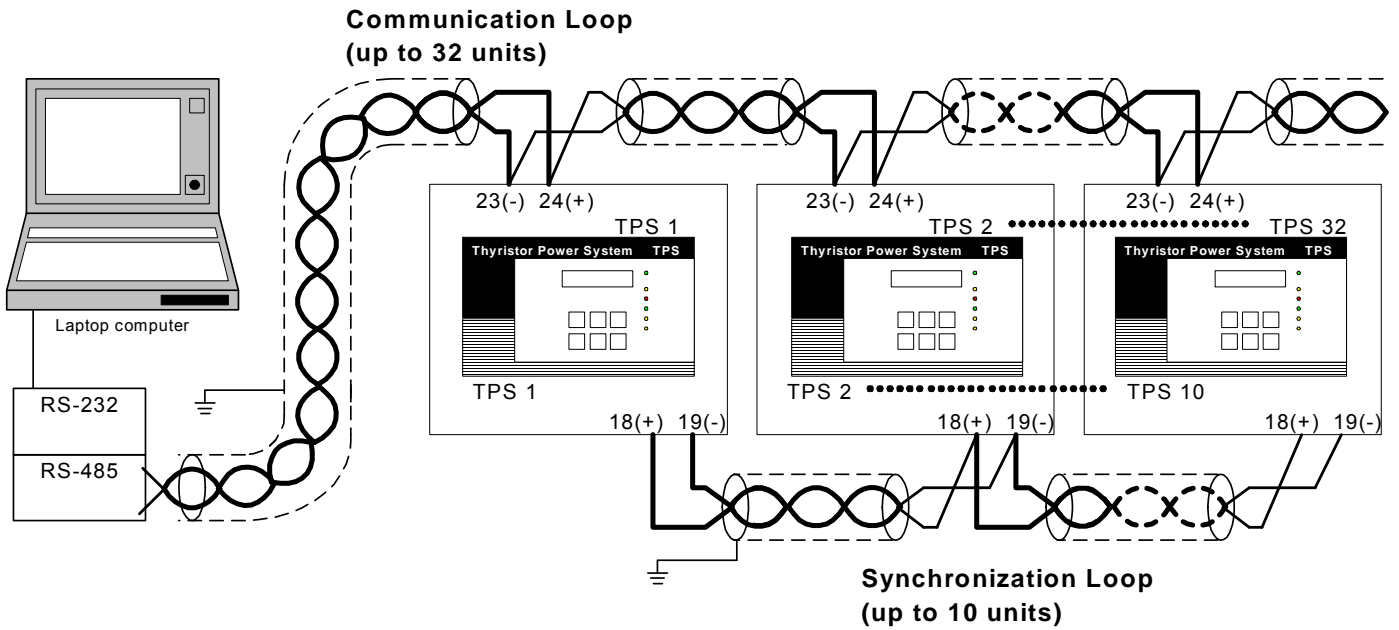

#### Notes:

- (1) – Use shielded twisted pair for Synchronization loop and for RS485 communication.
- (2) – For communication cabling length of cables should not exceed 200m.
- (3) - For Synchronization cabling length of cables should not exceed 20m.
- (4) - Synchronized mode can not be implemented if one current analogue input is connected to several TPS units in series.

#### 4.5 Wiring Notes

##### WARNINGS!

When mains voltage is connected to the TPS, even if control voltage is disconnected, full voltage may appear on the TPS load terminals. Therefore, for isolation purposes, it is necessary to connect an isolating device before the TPS.

Power factor correction capacitors must not be installed on TPS load side. When required, install capacitors on TPS line side.

#### 4.5.1 Short Circuit Protection

Protect the TPS thyristors against a short circuit by thyristor Protection Fuses. Thyristors I<sup>2</sup>t and fuses ratings are dictated in the following table:

Model	Max. Thyristor I <sup>2</sup> t (A <sup>2</sup> Sec)	BUSSMAN		GEC ALSTOM		SIBA		FERRAZ – SHAWMUT (IEC Style 690/700V)	
		Rated [A]	P/N	Rated [A]	P/N	Rated [A]	P/N	Rated [A]	P/N
TPS 8	5,000	50	FWP 50B	63	B210615			63	6.6URD30D11A0063
TPS 17	5,000	50	FWP 50B	63	B210615			63	6.6URD30D11A0063
TPS 31	5,000	50	FWP 50B	63	B210615			63	6.6URD30D11A0063
TPS 44	5,000	50	FWP 50B	63	B210615			63	6.6URD30D11A0063
TPS 58	12,000	125	FWP 125A	100	X320063			100	6.6URD30D11A0100
TPS 72	12,000	125	FWP 125A	100	X320063			100	6.6URD30D11A0100
TPS 85	12,000	125	FWP 125A	100	X320063			100	6.6URD30D11A0100
TPS 105	15,000	150	FWP 150A	125	X320065			125	6.6URD30D11A0125
TPS 145	60,000	250	FWP 250A	200	D320071	250	SQB1-250	250	6.6URD30D11A0250
TPS 170	60,000	250	FWP 250A	200	D320071	250	SQB1-250	250	6.6URD30D11A0250
TPS 210	140,000	400	FWP 400A	350	Y320480	350	SQB1-350	350	6.6URD30D11A0350
TPS 310	200,000	500	FWP 500A	450	D320485	450	SQB1-450	450	6.6URD30D11A0450
TPS 390	200,000	500	FWP 500A	450	D320485	450	SQB1-450	450	6.6URD30D11A0450
TPS 460	700,000	700	FWP 700A	800	T320591	800	SQB1-800	800	6.6URD31D11A0800
TPS 580	700,000	700	FWP 700A	800	T320591	800	SQB1-800	800	6.6URD31D11A0800
TPS 820	700,000	800	FWP 800A	800	T320591	800	SQB1-800	800	6.6URD31D11A0800
TPS 950									Consult Factory
TPS 1100									Consult Factory
TPS 1500									Consult Factory

#### 4.5.2 Transient Protection

Line transient voltages can cause a malfunction of the TPS and damage to the thyristors. All TPS units incorporate Metal Oxide Varistors (MOV) to protect from normal line voltage spikes.

When higher transients are expected, additional external protection should be used (consult factory).

## 5. DIMENSIONS

### TPS 8-72A

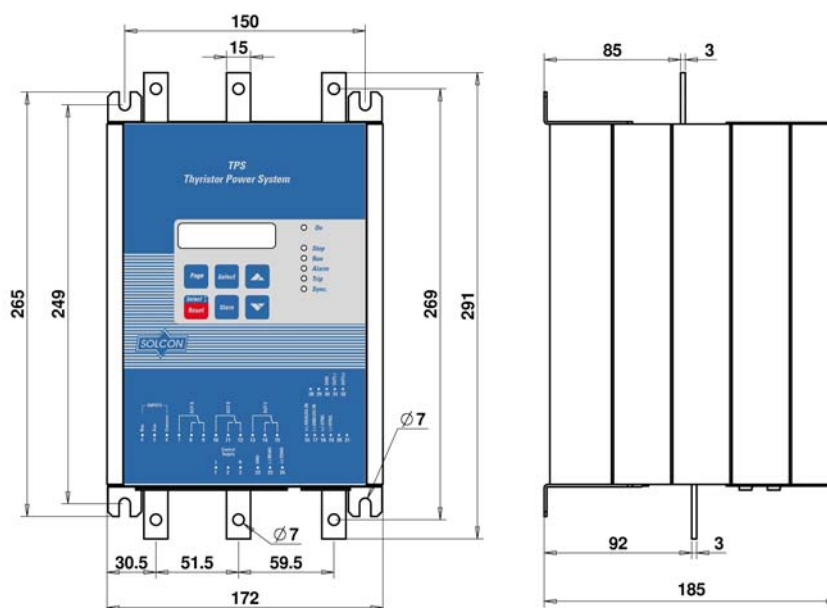

## TPS 85-105A

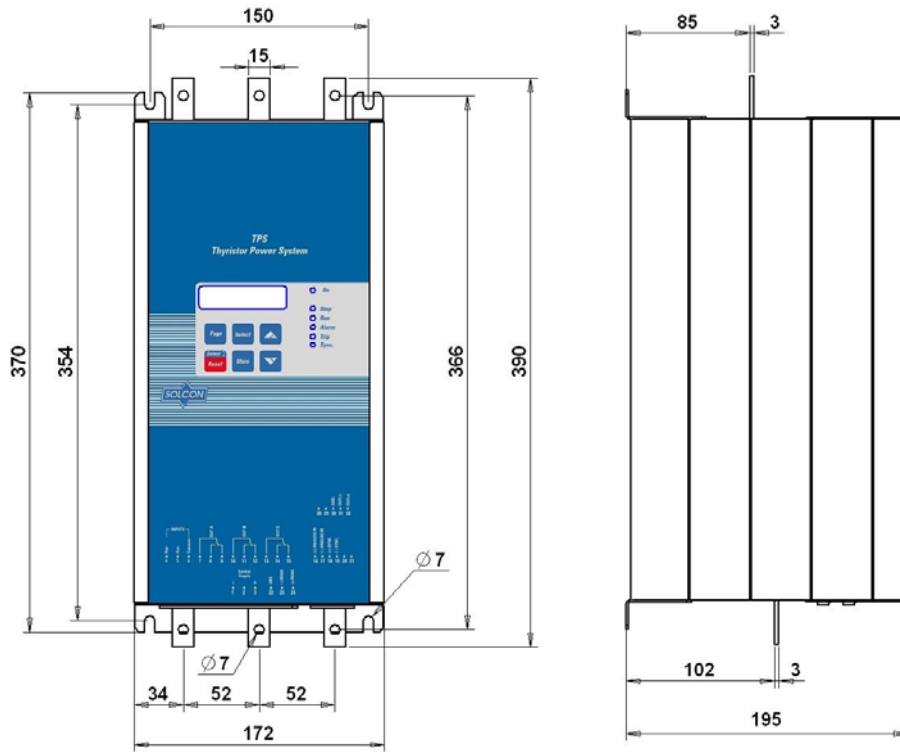

## TPS 145-210A

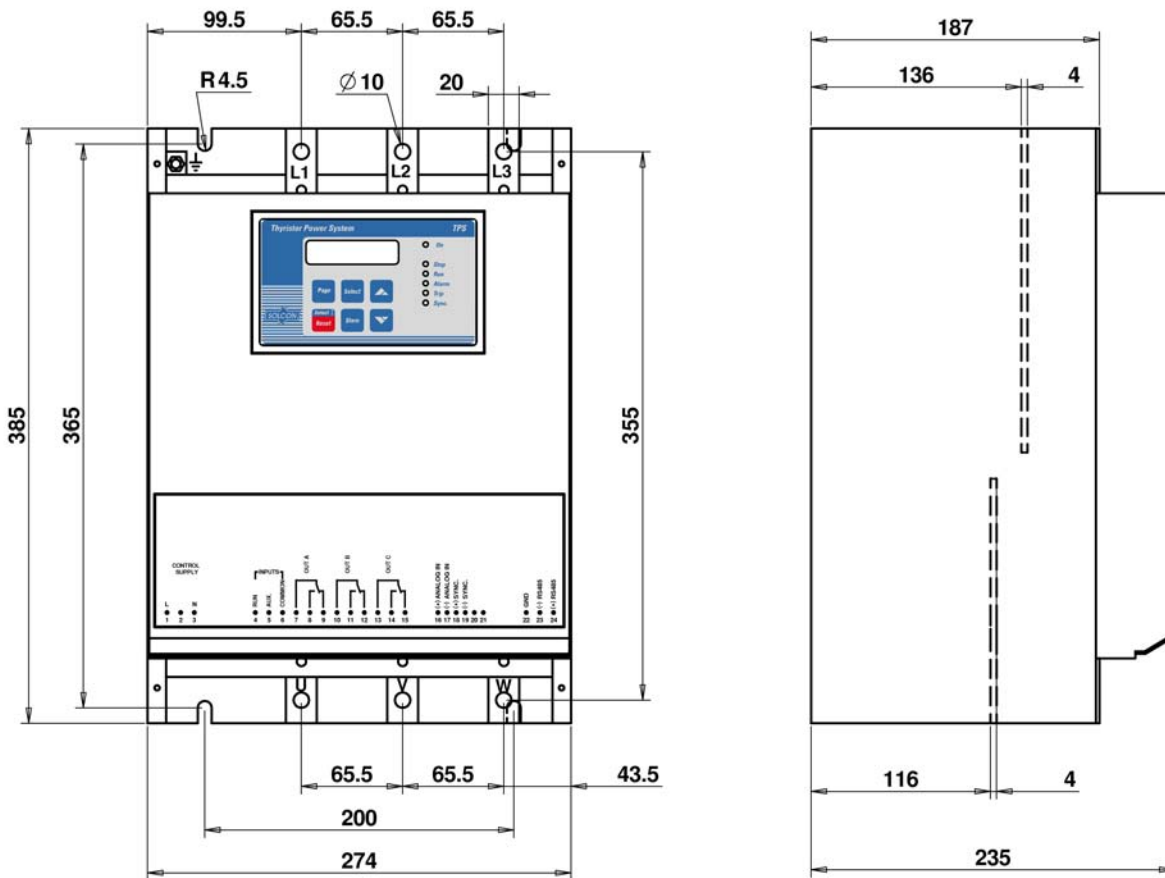



## TPS 580A

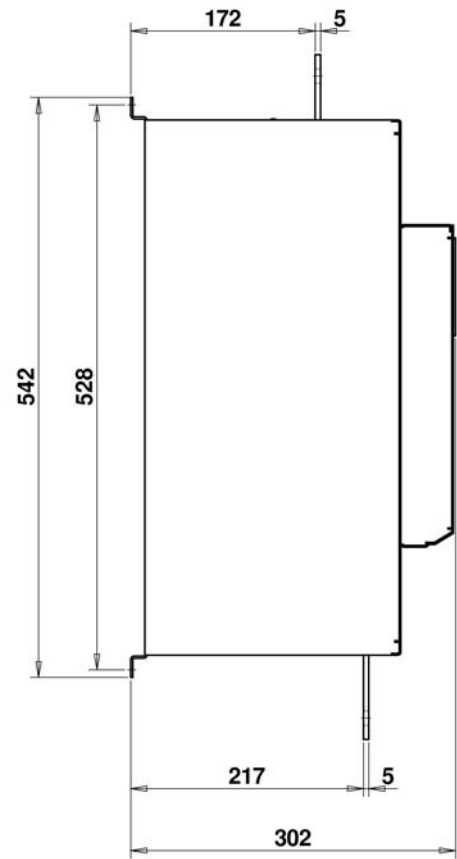
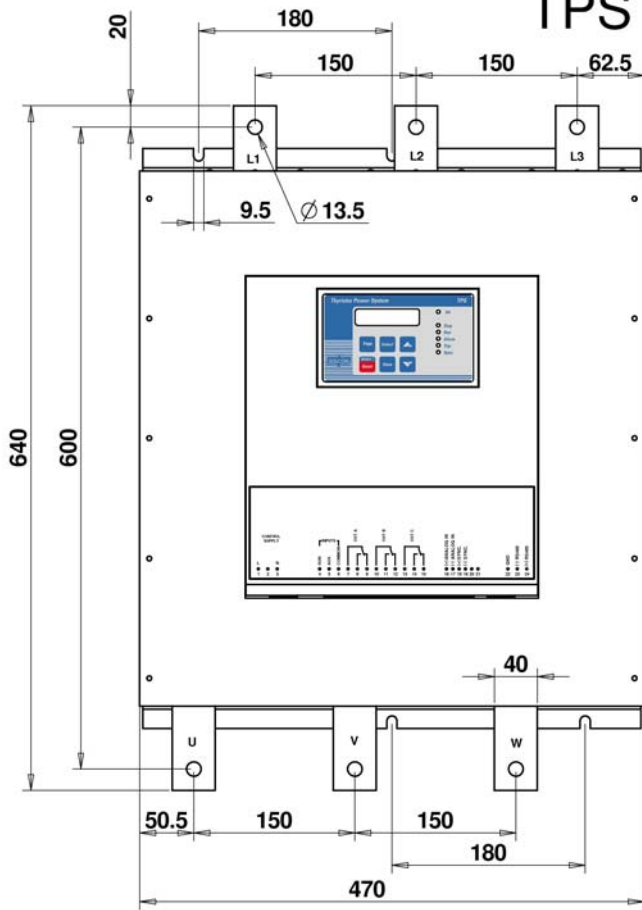

## TPS 820A

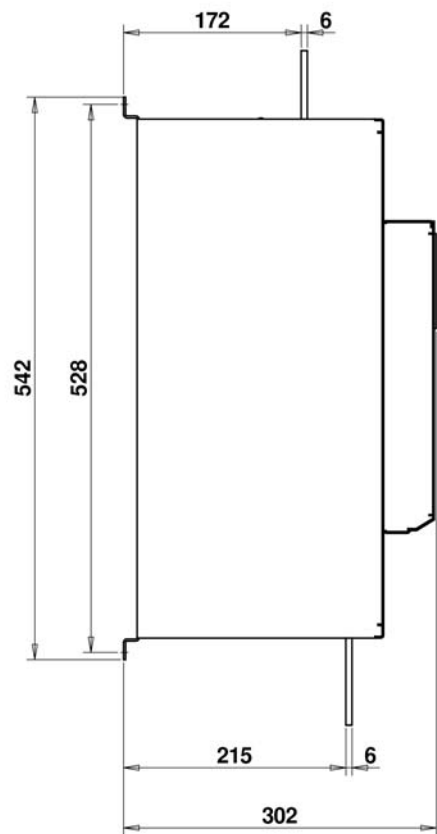
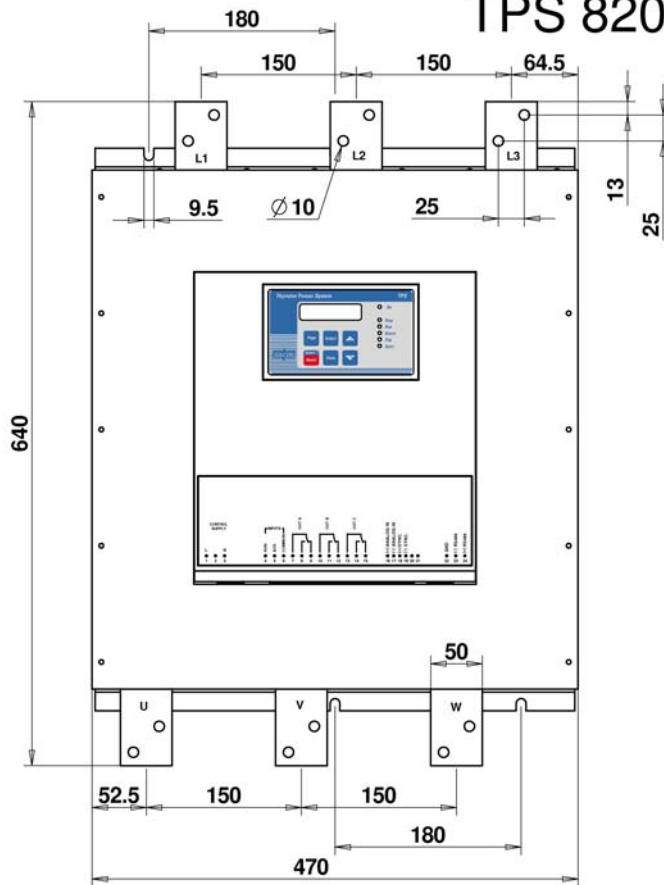

**For other models dimensions – consult factory.**

## 6. INSTALLATION

### WARNING!

Do not interchange line and load connections

### 6.1 Prior to Installation

Check that LOAD RATED CURRENT (FLA) is lower than, or equal, to the TPS RATED CURRENT.

#### **Note:**

TPS RATED CURRENT (FLC)  $\geq$  LOAD RATED CURRENT In all 3 phases!!

Check that Mains and Control voltages are as indicated on the TPS side label.

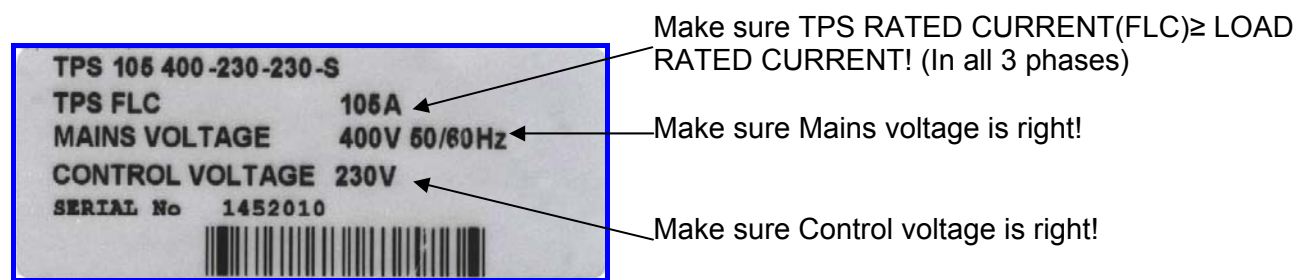

TPS label - example

### 6.2 Mounting

The TPS must be mounted vertically. Allow sufficient space (at least 100mm) above and below the TPS for suitable airflow.

It is recommended to mount the TPS directly on the rear metal plate for better heat dissipation.

#### **Note:**

Do not mount the TPS directly on the rear metal plate in case a ventilation fan or ventilation opening is on the back side of the TPS.

Do not mount the TPS near heat sources.

Surrounding air temperature in the cabinet should not exceed 50°C

Protect the TPS from dust and corrosive atmospheres.

**Note:** For harsh environments, it is recommended to order the TPS with printed circuit board coating. Refer to section 10 on page 40 for ordering information.

### 6.3 Temperature range & heat dissipation

The TPS is rated to operate over a temperature range of -10°C (14°F) to + 50°C (122°F).

Relative non-condensed humidity inside the enclosure should not exceed 95%.

### ATTENTION!

Operating at surrounding air temp. (Inside the cabinet) higher than 50°C may cause damage to the TPS.

Heat Dissipation is:

#### **1.3x3xI+FAN and TPS consumption rating**

Where:

I is the RMS current of the TPS.

**FAN and TPS consumption rating** - is shown on the technical specifications page 39.

So, for example, the maximum heat dissipation for a 210A TPS is:  $1.3 \times 3 \times 210 + 100 = 919 \text{ Watt}$ .

### 6.4 Jumpers settings for analogue input configuration

See next page for jumpers location.















The TPS incorporates 4 jumpers which configure terminals 16 & 17 to work as a voltage reference input, current reference input or voltage free potentiometer input.

Jumpers must be set correctly prior to start up.

**Caution:**

Damage may occur if jumpers are not properly set

The jumpers are located on the main PCB (Refer to control module picture on page 19) and should be set as follows:

	Description	Use
    	<p>JP1 and JP2 are closed JP3 and JP4 are open.</p> <p>* This is factory default setting.</p>	<p>Use when 0-20mA or 4-20mA is connected to terminals 16 &amp; 17. Refer to section 7.7.2 on page 27 for programming TPS ANALOG IN TYPE.</p>
    	<p>JP3 and JP4 are closed. JP1 and JP2 are open.</p>	<p>Use when 0-10V is connected to terminals 16 &amp; 17. Refer to section 7.7.2 on page 27 for programming TPS ANALOG IN TYPE.</p>
    	<p>JP4 is closed. JP1, JP2 and JP3 are open.</p>	<p>Use when potentiometer input is connected to terminals 16 &amp; 17 and 20. TPS must be programmed as "voltage input" 0..10V. Refer to section 7.7.2 on page 27 for programming TPS ANALOG IN TYPE.</p>

**Note:**



- Indicates closed jumper.
- Indicates open jumper.

### 6.5 Dip switches settings for analogue output optional PCB

See next page for analogue output optional PCB location.

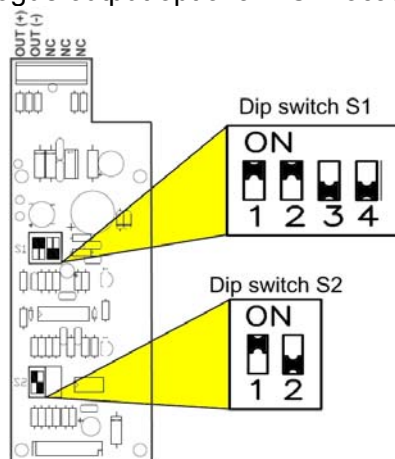

Analogue P.C.B. layout

**Analogue Output ( terminals Out (+), Out (-))**

Dip switches allow selection between: 0-10VDC, 0-20mA, 4-20mA

Analogue value can be programmed via the key pad in I/O PROGRAMMING SETTINGS page to one of the values as follows (refer to section 7.7.2 on page 27.):

- A. Power, 0-100% OF Pn (Default setting)
- B. I average, 0-100% OF LOAD RATED CURRENT.
- C. I1, 0-100% OF LOAD RATED CURRENT.
- D. I2, 0-100% OF LOAD RATED CURRENT.
- E. I3, 0-100% OF LOAD RATED CURRENT.
- F. ANALOG INPUT (reflection of analogue input to the TPS)

Dip No.	4-20 mA*	0-20 mA	0-10VDC
Dip-Sw. S1 # 1	On	On	Off
Dip-Sw. S1 # 2	On	On	Off
Dip-Sw. S1 # 3	Off	Off	On
Dip-Sw. S1 # 4	Off	Off	On
Dip-Sw. S2 # 1	On	Off	Off
Dip-Sw. S2 # 2	No use	No use	No use



\* Factory default setting



## 7. CONTROL KEYPAD

The control keypad is the link between the TPS and the user.

The TPS control keypad features:

- (1) Two lines of 16 alphanumeric characters each (with four selectable languages – English, French, German and Spanish)
- (2) Six push-buttons (**Page**, **Select/Reset**, **Select**, **Store**, Up (  ) and down (  ) keys.
- (3) Six indication LEDs (*On*, *Stop*, *Run*, *Alarm*, *Trip* and *Sync*)

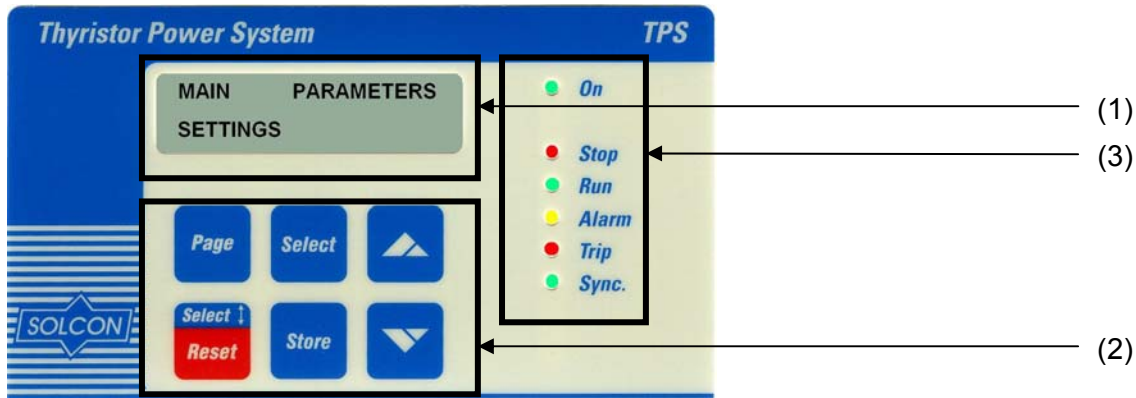







### 7.1 LCD Arrangement

UNDER CURRENT  
0% OF FLA







Upper line displays function.

Lower line displays setting and/or measured values.

### 7.2 Push-buttons



	Allows the operator to browse through the Display and programming menus available in the TPS.
	Allows the operator to select a function within each <b>Page</b> . <b>Note:</b> Pressing <b>Select</b> continuously changes shown parameters continuously.
	Allows the operator to increase adjusted values shown in the display. Operator should press this button momentarily, for slow value changes in the display, or continuously, for rapid value changes in the display.
	Allows the operator to decrease adjusted values shown in the display. Operator should press this button momentarily, for slow value changes in the display, or continuously, for rapid value changes in the display.
	Allows the operator to store modified parameters in the non-volatile memory to save modified parameters.
	This key has two functions: <ul style="list-style-type: none"> <li>• Used to toggle between “backwards” and “forward” While pressing <b>Select</b> key. When pressing <b>Select</b> key, an underline mark will show/not show on the first digit of the second row of the display. While underline mark shows – <b>Select</b> key goes “backwards” While underline mark does not show – <b>Select</b> key goes “forward”</li> <li>• When TPS is in latched trip or in alarm status allows the user to reset the unit. The Reset key has to be pressed for 1 second in order to</li> </ul>

### 7.3 Status LEDs.

	Green	<i>On</i>	Lights when Control Supply voltage is connected to the TPS
	Red	<i>Stop</i>	Lights when TPS is in stop condition. (Before RUN command is initiated)
	Green	<i>Run</i>	Lights when TPS is feeding the load.
	Yellow	<i>Alarm</i>	Lights during alarm condition. Note: LED can be latched on/off as per AUTO RESET ENABLE/DISABLE setting. Refer to section 7.7.5 page 32.
	Red	<i>Trip</i>	Lights during trip condition. Note: LED can be latched on/off as per AUTO RESET ENABLE/DISABLE setting. Refer to section 7.7.5 page 32.
	Green	<i>Sync.</i>	Lights when TPS is programmed to MASTER or SLAVE mode of operation. Refer to section 3.8 page 9 for more details.

### 7.4 Reviewing and modifying parameters

Press **Page** key several times until you reach the required Mode page.  
Press **Select** key to review parameters of this Mode.

When reaching the required parameter, modify its values with  or  keys.

Once value is set press **Store key**. Once data was properly stored in the non-volatile memory, the LCD will display DATA SAVED OK for 2 seconds.

In addition the modified parameter/s can be stored at the end of every mode page. Press **Select** until "STORE ENABLE To store the new parameters, press **Select** key until STORE ENABLE XXX PARAMETERS, then press **Store** key. The LCD will display DATA SAVED OK for 2 seconds.

### 7.5 Special actions performed by the key-pad.

#### 7.5.1 Run self test, Software version, default parameters and clear statistical data

Press **Page** and  keys simultaneously.

The LCD will display:

```
TEST / MAINTENANCE
*****OPTIONS*****
```

Press **Select** key.

The LCD will display:

```
RUN SELF TEST?
PUSH UP ARROW
```

To perform a self test push UP ARROW.

If self test OK, display will show:

```
SELF TEST PASSED
```

Press **Select** key.

The LCD will display the software version:

```
DTL-19/03/2006
TPS-190306noSTAT
```

Press **Select** key.

The LCD will display:

```
STORE NOW?
DEFAULT PARAMETERS
```

To obtain "default parameters" press **Page+Store** Simultaneously.

The LCD will display:

DATA SAVED OK

At this point (If “default parameters” were obtained) the TPS goes back to the root menu. In order to continue the TEST/MAINTENANCE procedure press **Select** several times until LCD displays:

CLEAR NOW?  
STATISTICAL DATA

To clear “statistical data” press **Reset+Store** Simultaneously. The LCD will display:

DATA SAVED OK

### CAUTION!

Obtaining Default Parameters erases all previously modified settings and requires the operator to program TPS RATED CURRENT, LOAD RATED CURRENT (FLA) and RATED LINE VOLTAGE values again.

## 7.6 Mode Pages

Upon initiation of the TPS, the LCD displays:

MAIN PATAMETERS  
SETTINGS

By pressing the **Page** key all mode pages can be reviewed:

MAIN PATAMETERS  
SETTINGS

I/O PARAMETERS  
SETTINGS

PROTECTION PARA.  
SETTINGS

LOAD SHED. PARA.  
SETTINGS

TRIPPING/ALARM  
- \*\*\*\* -

COMM. PARAMETERS  
SETTINGS

ACTUAL DATA  
- \*\*\*\* -

FAULT DATA  
- \*\*\*\* -

### Notes:

1. Pressing **Store** key while the LCD displays an "Actual Data" parameter, will store this parameter as default display. If no key is pressed for more than five minutes, this parameter will be constantly displayed.
2. Pressing **Store** key, while the LCD displays a header, will store this header as the default display. If no key is pressed for more than five minutes this header will be constantly displayed.

## 7.7 Mode Pages, parameters &amp; default values

MAIN PARAMETERS SETTINGS	I/O PARAMETERS SETTINGS	PROTECTION PARA. SETTINGS	LOAD SHED. PARA. SETTINGS	TRIPPING/ALARM ***OPTIONS***
See page 25	See page 27	See page 29	See page 31	See page 32
Display and default values	Display and default values	Display and default values	Display and default values	
LINE VOLTS (Vn) 400V	ANALOG IN TYPE 4 .. 20mA	UNDER CURRENT 0 % OF FLA	CURRENT LIMIT OFF	
LINE FREQUENCY 50 Hz	ANALOG IN T. CONST 1.0 SEC.	U/C DELAY 10.0 SEC.	MASTER/SLAVE OFF	
TPS RATED CURR. 100 AMP.	AUX. IN TYPE REMOTE RESET	OVER CURRENT 0 % OF FLA	NO. OF SYNC UNITS 5	
LOAD RATED CURR. 100 AMP.	CONFIG OUT A RUN (IMMEDIATE)	O/C DELAY 5.0 SEC.	SYNC. NUMBER 2	
LOAD RATED POWER 70.5 KW	OUT A RELAY DLY 0.0 SEC.	UNBALANCE LVL 1 10% OF FLA	STORE ENABLE LOAD SHED. PARA.	
CONNECTION TYPE WYE, NEUTRAL CON	CONFIG OUT B ALARM-FAIL SAFE	U/B LVL 1 DELAY 10.0 SEC.		
LOAD POWER FACTOR 1.0	OUT B RELAY DLY 0.0 SEC.	UNBALANCE LVL 2 20% OF FLA		
FIRING METHOD ZERO CROSSING	CONFIG OUT C TRIP	U/B LVL 2 DELAY 5.0 SEC.		
CONTROL MODE INPUT SIGNAL	OUT C RELAY DLY 0.0 SEC.	UNDER VOLTAGE 80 % OF Vn		
ON-OFF CYCLE T 2.0 SEC.	KWH PER PULSE OFF	U/V DELAY 5.0 SEC.		
TURN ON DELAY 0.0 SEC.	AN. OUT PARAMETER P, 0-100% OF Pn	OVER VOLTAGE 115 % OF Vn		
TURN OFF DELAY 0.0 SEC.	STORE ENABLE I/O PARAMETERS	O/V DELAY 1.0 SEC.		
PARAM. SETTING NOT LOCKED		PHASE LOSS DELAY 2.0 SEC.		
STORE ENABLE MAIN PARAMETERS		GND FAULT LEVEL 10 % OF FLA		
		GND FAULT DELAY 2.0 SEC.		
		UNDER POWER LVL 0 % OF Pn		
		UNDER POWER DLY 10.0 SEC.		
		EXT. FAULT DELAY 5.0 SEC.		
		STORE ENABLE PROTECTION PARA.		

COMM.PARAMETERS SETTINGS	ACTUAL DATA --****--	STATISTICAL DATA - **** -	FAULT DATA - **** -
<b>See page 33</b>	<b>See page 34</b>	<b>See page 35</b>	<b>See page 35</b>
<b>Display and default values</b>	<b>Display</b>	<b>Display</b>	<b>Display</b>
COMM. PROTOCOL MODBUS	Vp1 Vp2 Vp3 0 0 0 V	TOTAL RUN TIME 0 HOURS	LAST TRIP NO DATA
BAUD RATE 19200	VL12 VL23 VL31 0 0 0 V	TOTAL # OF TRIPS 0	LAST ALARM NO DATA
PARITY CHECK EVEN	ANALOG INPUT 26%	TOTAL ENERGY 0 KWH	TRIP I1 I2 I3 0 0 0 A
SERIAL LINK NO. 248 (OFF)	ON I1 I2 I3 0 0 0 A		TRIP GND CURRENT 0 AMP.
S.LINK PAR. SAVE DISABLE	GROUND CURRENT 0 AMP.		TRIP Vp1 Vp2 Vp3 0 0 0 V
SER.LINK CONTROL DISABLE	FREQUENCY 50 Hz		LAST 10 TRIPS: NO DATA
STORE ENABLE COMM. PARAMETERS	POWER 0 KW		PREVIOUS TRIP -2 NO DATA
	LOAD CURRENT 0 % OF FLA		.
	UNBALANCE CURR. 0 %		PREVIOUS TRIP -9 NO DATA

## 7.7.1 Main parameters settings – page 1

MAIN PARAMETERS SETTINGS		
Display and default values	Range	Description
LINE VOLTS (Vn) 400V	120V-690V	Sets TPS mains voltage
LINE FREQUENCY 50 Hz	50Hz, 60Hz	Sets TPS mains frequency
TPS RATED CURR. 100 AMP.	8A-3000A	Sets TPS RATED CURRENT (FLC) TPS RATED CURRENT should be as shown on the TPS Name plate. (Refer to section 6.1 on page 17)
LOAD RATED CURR. 100 AMP.	8A-3000A	Sets LOAD RATED CURRENT (FLA). Should be programmed as shown on load's name plate. <b>Note:</b> LOAD RATED CURRENT ≤ TPS RATED CURRENT in <b>all</b> 3 phases.
LOAD RATED POWER 70.5 KW	0.1kW- 3600kW	Sets load rated power. This parameter is set to enable the TPS to close a control loop when in PHASE CONTROL- POWER mode of operation. Refer to section 3.7.4 on page 8.
CONNECTION TYPE WYE, NEUTRAL CON	INSIDE DELTA, DELTA, WYE, NEUTRAL NC, WYE, NEUTRAL CON	Sets connection mode of the TPS. Refer to section 4.1 on page 10. <b>Caution:</b> WYE, NEUTRAL NC applicable for symmetrical loads only. Connecting to non symmetrical loads might damage the load! When WYE, NEUTRAL NC applies set the UNBALANCE protection to the lowest practical value and trip the TPS upon UNBALANCE or else load will damage. Refer to section 7.7.3 on page 29.
LOAD POWER FACTOR 1.0	0.00-1.0	Sets load rated power factor.
FIRING METHOD ZERO CROSSING	PC TO ZC IN 1 SEC. . PC TO ZC IN 60 SEC. PH. CTRL – POWER PHASE CONTROL ZERO CROSSING	Sets TPS mode of operation Refer to section 4.13.7 on page 7.
CONTROL MODE INPUT SIGNAL	INPUT SIGNAL	Reserved for future enhancement.
ON-OFF CYCLE T 2.0 SEC.	1.0sec. – 10sec.	Sets TPS cycle time when operating in ZERO CROSSING. Refer to section 3.7.1 on page 7.
TURN ON DELAY 0.0 SEC.	0.0sec. – 60sec.	Sets TPS ON DELAY. This feature is used when several units get ON command instantaneously. Programming different delays will prevent sudden loading the supply.
TURN OFF DELAY 0.0 SEC.	0.0sec. – 60sec.	Sets TPS OFF DELAY. This feature is used when several units get OFF command instantaneously. Programming different delays will prevent sudden unloading the supply.

MAIN PARAMETERS SETTINGS		
Display and default values	Range	Description
PARAM. SETTING NOT LOCKED	LOCKED OUT NOT LOCKED	Locks or unlocks parameter modifications.
STORE ENABLE MAIN PARAMETERS		<p>Storing modified parameters To store selected parameters, press <b>Store</b> key.</p> <p><b>Note:</b> Storing more than one parameter possible only when the TPS is not running. While TPS is running each parameter can be changed individually by pressing <b>Store</b> key after modifying the parameter. When parameters are correctly stored, the LCD will read:</p> <div style="border: 1px solid black; padding: 5px; width: fit-content; margin: 10px auto;">DATA SAVED OK</div> <p><b><u>This concludes MAIN PARAMETER settings.</u></b> Pressing Select key after DATA SAVED OK returns to the first display in this mode.</p> <p><b>Note:</b> In case of a failure in parameter storing, the LCD displays:</p> <div style="border: 1px solid black; padding: 5px; width: fit-content; margin: 10px auto;">STORAGE ERROR</div> <p>In this case Refer to section 8 – “TROUBLE SHOOTING” on page 36.</p>

## 7.7.2 I/O Parameters – page 2

I/O PARAMETERS SETTINGS		
Display and default values	Range	Description
ANALOG IN TYPE 4 .. 20 mA	0 .. 10 V 0 ..20 mA 4 .. 20 mA	<p>Sets TPS type of input control input. (Terminals 16-17)</p> <p><b>0 .. 10V</b> is programmed when analogue input is 0 .. 10V or potentiometer option is installed.</p> <p><b>0 .. 20mA</b> is programmed when analogue input is 0 .. 20mA.</p> <p><b>4 .. 20mA</b> is programmed when analogue input is 4 .. 20mA.</p> <p><b>Notes:</b></p> <ol style="list-style-type: none"> <li>Customer must set jumpers settings to set TPS hardware for programmed ANALOG IN TYPE. Refer to section 6.4 on page 18.</li> <li>When using potentiometer option program ANALOG IN TYPE to 0 .. 10V.</li> <li>Synchronized mode can not be implemented if one current analog input is connected to several TPS units in series.</li> </ol>
ANALOG IN T. CONST 1.0 SEC.	0.0 SEC. – 10.0 SEC.	<p>Sets TPS time constant.</p> <p>This parameter, together with FIRING METHOD (PC TO ZC in 1 .. 60 SEC – refer to section 7.7.1 page 25) is used to “soft start” the load. Refer to section 3.7.3 page 8 for more details.</p>
AUX. IN TYPE REMOTE RESET	SYNC. AUTHORIZED KEY REMOTE RESET N.C. EXT. FAULT N.O. EXT. FAULT N.C. INTERLOCK N.O. INTERLOCK	<p>Sets TPS AUX IN TYPE. (Terminal 5).</p> <p><b>SYNC.</b> Is for future enhancement.</p> <p><b>AUTHORIZED KEY</b> is programmed to prevent parameter modifications.</p> <p><b>N.O./N.C. EXT. FAULT</b> is programmed when auxiliary fault signal is initiated to the TPS.</p> <p><b>N.C./N.O. INTERLOCK</b> is programmed to interlock the TPS with auxiliary signals.</p>
CONFIG OUT A RUN (IMMEDIATE)	KWH PULSE RELAY TRIPPING/ALARM TRIP-FAIL SAFE TRIP ALARM-FAIL SAFE ALARM RUN (IMMEDIATE)	<p>Sets TPS functions of output relay A (Terminals 7, 8, 9)</p> <p><b>KWH PULSE RELAY</b> is programmed when output pulse is needed for KWH metering. The rated KWH/pulse is programmed in KWH PER PULSE parameter. (See here after)</p> <p><b>TRIPPING/ALARM</b> is programmed when this OUT RELAY is programmed as TRIPPING/ALARM.</p> <p><b>TRIP-FAIL SAFE</b> is programmed when this OUT RELAY is programmed as TRIP-FAIL SAFE.</p> <p><b>TRIP</b> is programmed when this OUT RELAY is programmed as TRIP.</p> <p><b>ALARM-FAIL SAFE</b> is programmed when this OUT RELAY is programmed as ALARM-FAIL SAFE.</p> <p><b>ALARM</b> is programmed when this OUT RELAY is programmed as ALARM.</p> <p><b>RUN (IMMEDIATE)</b> is programmed when this OUT RELAY is programmed as RUN (IMMEDIATE) and closes when TPS is in RUN mode.</p>
OUT A RELAY DLY 0.0 SEC.	0.0 SEC.-60.0 SEC.	Sets delay time for this OUT RELAY.

<b>I/O PARAMETERS SETTINGS</b>		
CONFIG OUT B ALARM-FAIL SAFE	Same as CONFIG OUT A – See above.	Sets TPS functions of output relay B (Terminals 10, 11, 12) Same as CONFIG OUT A – See above.
OUT B RELAY DLY 0.0 SEC.	0.0 SEC.-60.0 SEC.	Sets delay time for this OUT RELAY.
CONFIG OUT C TRIP	Same as CONFIG OUT A – See above.	Sets TPS functions of output relay C (Terminals 13, 14, 15) Same as CONFIG OUT A – See above.
OUT C RELAY DLY 0.0 SEC.	0.0 SEC.-60.0 SEC.	Sets delay time for this OUT RELAY.
KWH PER PULSE OFF	OFF, 1KWH - 100KWH	Sets KWH/Pulse for KWH metering. OUT A or OUT B or OUT C must be programmed to KWH PULSE RELAY in order that this function will be effective. (See above)
AN. OUT PARAMETER P, 0-100% OF Pn	P, 0-100% OF Pn I, 0-100% OF FLA. I1, 0-100% OF FLA. I2, 0-100% OF FLA. I3, 0-100% OF FLA. ANALOG INPUT	Sets TPS analogue output (optional). (Terminals out(+), out(-). Dip switches on the analogue output PCB allow selection between: 0-10VDC, 0-20mA, 4-20mA Refer to section 6.5 page 18 for dip switch settings.  <b>P, 0-100% OF Pn</b> - is programmed when analogue output is related to Pn. <b>I, 0-100% OF FLA</b> - is programmed when analogue output is related to average I as a percentage of LOAD RATED CURRENT. <b>I1(I2, I3), 0-100% OF FLA</b> - is programmed when analogue output is related to I1 (I2, I3) as a percentage of LOAD RATED CURRENT. <b>ANALOG INPUT</b> - is programmed when analogue output is a reflection of analogue input.
STORE ENABLE I/O PARAMETERS		Same as STORE ENABLE MAIN PARAMETERS On page 26.

## 7.7.3 Protection Parameters – page 3

PROTECTION PARA. SETTINGS		
	<p><b>Note:</b> The settings of the PROTECTION PARAMETERS listed below are related to the level and time delay of each protection parameter. The functionality of each protection must be programmed in the TRIPPING /ALARM OPTIONS. Refer to section 7.7.5 page 32.</p>	
Display and default values	Range	Description
UNDER CURRENT 0 % OF FLA	0 %-95%	<p>Sets the value in % of “load rated current” below which the UNDER CURRENT protection is triggered.</p> <p><b>Note:</b> When TPS is in ZERO CROSSING mode of operation, the measured current used for this function is the ON state current value.</p>
U/C DELAY 10.0 SEC.	0.1 SEC.-60.0 SEC.	Sets the time delay for the UNDER CURRENT protection after current has reached the pre-set level.
OVER CURRENT 0 % OF FLA	50 %-150%	<p>Set the value in % of load rated current above which the OVER CURRENT protection is triggered.</p> <p><b>Notes:</b> 1. When TPS is in ZERO CROSSING mode of operation, the measured current used for this function is the ON state current value. 2. O/C includes also fast (&lt; 60mS) O/C with fixed level of 180% TPS RATED CURRENT.</p>
O/C DELAY 5.0 SEC.	0.1 SEC.-60.0 SEC.	Sets the time delay for the OVER CURRENT protection after current has reached the pre-set level.
UNBALANCE LVL 1 10% OF FLA	1%-100%	<p>Sets the protection for unbalanced load conditions such as disconnected (failed) load resistor(s). This function is calculated according to : <math>(I_{max} - I_{min})/I * 100</math>. Where: <b>I<sub>max</sub></b> - is the maximum current measured in any phase <b>I<sub>min</sub></b> - is the minimum current measured in any phase. <b>I</b> – is the larger value of Load Rated Current or actual phase maximum phase current .</p> <p><b>Notes:</b> When TPS is in ZERO CROSSING mode of operation, the measured current used for this function is the ON state current value. When WYE, NEUTRAL NOT CONNECTED (NC) applies set this protection to the lowest practical value and trip the TPS upon UNBALANCE or else load will damage.</p>
U/B LVL 1 DELAY 10.0 SEC.	1.0 SEC.-60.0 SEC	Sets the time delay for the CURRENT UNBALANCE LEVEL 1 protection after current unbalance has reached the above set level.
UNBALANCE LVL 2 20% OF FLA	1%-100%	Same as UNBALANCE LVL 1.
U/B LVL 2 DELAY 5.0 SEC.	1.0 SEC.-60.0 SEC	<p>Sets the time delay for the CURRENT UNBALANCE LEVEL 2 protection after current unbalance has reached the pre-set level.</p> <p><b>Note:</b> Set the parameter at a higher value than U/B LVL 1 time delay.</p>

<b>PROTECTION PARA. SETTINGS</b>		
	<b>Note:</b> The settings of the PROTECTION PARAMETERS listed below are related to the level and time delay of each protection parameter. The functionality of each protection must be programmed in the TRIPPING /ALARM OPTIONS. Refer to section 7.7.5 page 32.	
<b>Display and default values</b>	<b>Range</b>	<b>Description</b>
UNDER VOLTAGE 80 % OF Vn	50 %-95%	Sets the value in % of line rated voltage below which the UNDER VOLTAGE protection is triggered. Active during RUN conditions only.
U/V DELAY 5.0 SEC.	1.0 SEC.-60.0 SEC	Sets the time delay for the UNDER VOLTAGE protection after voltage has reached pre-set level.
OVER VOLTAGE 115 % OF Vn	100 %-120%	Sets the value in % of line rated voltage above which the OVER VOLTAGE protection is triggered.
O/V DELAY 1.0 SEC.	0.1 SEC.-60.0 SEC.	Sets the time delay for the OVER VOLTAGE protection after voltage has reached pre-set level
PHASE LOSS DELAY 2.0 SEC.	1.0 SEC.-60.0 SEC	Sets the time delay for the PHASE LOSS protection after phase loss has been detected.
GND FAULT LEVEL 10 % OF FLA	10 %-100%	Sets the GROUND FAULT protection level in % of the vector sum of the three phase current (zero sequence). <b>Note:</b> Not active when WYE NEUTRAL CON connection type is programmed.
GND FAULT DELAY 2.0 SEC.	1.0 SEC.-60.0 SEC	Sets the time delay for the GROUND FAULT protection after voltage has reached above set level
UNDER POWER LVL 0 % OF Pn	0 %-95%	Programmable value in % of load actual power below which the UNDER POWER protection is triggered. <b>Note:</b> When TPS is in ZERO CROSSING mode of operation, the measured power taken for this function is the ON State power X ON time/ (ON time+ OFF time).
UNDER POWER DLY 10.0 SEC.	5.0 SEC.-60.0 SEC	Sets the time delay for the UNDER POWER protection after power has reached above set level.
EXT. FAULT DELAY 5.0 SEC.	0.0 SEC.-60.0 SEC	Programmable time delay for EXTERNAL FAULT signal after control voltage has been applied to terminal 5 (AUX. IN) and NO or NC EXTERNAL FAULT has been programmed (Refer to section 7.7.2 page 27 for programming AUX. IN TYPE )
STORE ENABLE PROTECTION PARA.		Same as STORE ENABLE MAIN PARAMETERS On page 26.

## 7.7.4 Load shedding parameters settings– page 4

LOAD SHED. PARA. SETTINGS		
Display and default values	Range	Description
CURRENT LIMIT OFF		This function is for future enhancement.
MASTER/SLAVE OFF	MASTER SLAVE OFF	Program the TPS to work un a synchronization mode. Refer to section 3.8 page 9 for more details. <b>OFF</b> – Load Shedding feature is disabled. <b>SLAVE</b> – The TPS unit is controlled by another TPS unit programmed as MASTER. <b>MASTER</b> – The TPS unit controls a number (up to 9) of other TPS units <b>Note:</b> Synchronized mode can not be implemented if one current analog input is connected to several TPS units in series.
NO. OF SYNC UNITS 5	2-10	Programmable to the number of units to be connected together as one synchronized group. e.g. - Set to 4, when one master and three slaves are used. <b>Note:</b> When setting this parameter, take into consideration, the % of rated power, required for maintaining the temperature at the “steady state” condition. If, for example the required power is 25% of rated, then setting "no. of sync units" = 4 (1 master + 3 slaves), is reasonable.
SYNC. NUMBER 2	1-10	Programmable “Sync communication” address of each TPS unit. MASTER unit must be set to 1. TPSs programmed as SLAVE should be set for addresses 2 and up to 10.
STORE ENABLE LOAD SHED. PARA.		Same as STORE ENABLE MAIN PARAMETERS On page 26.

7.7.5 **Tripping/alarm parameters – page 5**

For easy viewing, tripping/alarm pages are not listed as in other pages but as a table.

**Notes:**

1. **All protections MUST be programmed in this page in order to be operative!!**
2. Each of the faults listed below can be programmed as DISABLED (-) or ENABLED (+)
3. The table below shows factory defaults.

<b>FAULT</b>	<b>Trip</b>	<b>Alarm</b>	<b>Auto Reset</b>	<b>Panel Reset</b>	<b>Remote Reset</b>	<b>Output A</b>	<b>Output B</b>	<b>Output C</b>
UNDER CURRENT	-	+	-	+	+	-	-	-
OVER CURRENT	+	+	-	+	+	-	-	-
UNBALANCE LVL 1*	-	+	-	+	+	-	-	-
UNBALANCE LVL 2 *	+	+	-	+	+	-	-	-
UNDER VOLTAGE	-	+	-	+	+	-	-	-
OVER VOLTAGE	+	+	-	+	+	-	-	-
PHASE LOSS	+	+	-	+	+	-	-	-
GROUND FAULT	-	+	-	+	+	-	-	-
UNDER POWER	-	+	-	+	+	-	-	-
SHORTED SCR	-	+	-	+	+	-	-	-
WRONG CONCT TYPE	+	+	-	+	+	-	-	-
HEAT SINK OVER T.	-	+	-	+	+	-	-	-
EXTERNAL FAULT	-	-	-	+	+	-	-	-
COMM PORT FAILED	-	+	-	+	+	-	-	-
INTERNAL FAILURE	-	+	-	+	+	-	-	-

\* For calculation method of UNBALANCE LVL1&2 refer to section 7.7.3 on page 29.

## 7.7.6 Comm. Parameters – page 8

<b>COMM.PARAMETERS SETTINGS</b>		
<b>Display and default values</b>	<b>Range</b>	<b>Description</b>
COMM. PROTOCOL MODBUS	MODBUS	Sets TPS communication PROTOCOL. Available only when Communication card is installed.
BAUD RATE 19200	1200, 2400, 4800, 9600, 19200	Sets TPS BAUD RATE. Available only when Communication card is installed.
PARITY CHECK EVEN	EVEN, ODD	Sets TPS communication PARITY CHECK. Available only when Communication card is installed.
SERIAL LINK NO. 248 (OFF)	1 – 248 (off)	Sets TPS communication SERIAL LINK NO. Available only when Communication card is installed.
S.LINK PAR. SAVE DISABLE	ENABLE DISABLE	When set to DISABLE, it prevents parameter setting through serial link communication. When set to Enable, parameter setting through serial link is enabled.
SER.LINK CONTROL DISABLE	DISABLE ATART/STOP FULL	When DISABLE is selected control via serial link is not possible. When START/STOP is selected, a START, STOP and RESET commands can be initiated via the serial link. When FULL is selected, all commands as in START/STOP option can be initiated via the serial link and, in addition, the value of the analog input is taken from the serial link. <b>Note:</b> When FULL option is selected, the wired analog input (Terminals 16, 17 and 20) of the TPS is not active.
STORE ENABLE COMM. PARAMETERS		Same as STORE ENABLE MAIN PARAMETERS On page 26.

7.7.7 **Actual data – page 9**

<b>ACTUAL DATA</b> --****--		
<b>Display</b>		<b>Description</b>
Vp1    Vp2    Vp3 0      0      0    V		Displays system phase voltage. If no neutral in the system, a “virtual ground” is used for measuring phase voltage.
VL12   VL23   VL31 0      0      0    V		Displays system line voltage.
ANALOG INPUT 26%		Displays ANALOG INPUT rate.
ON    I1    I2    I3 0      0      0    A		Displays currents of 3 phases. The current shown is when TPS is in “ON” during the “ON-OFF CYCLE T” in “ZERO CROSSING” MODE. This display (with “ON” shown on top left of the display) shown in “ZERO CROSSING” mode. In “PHASE CONTROL” mode the “ON” is not shown on the display.
GROUND CURRENT 0 AMP.		Display calculated GROUND CURRENT. <b>Notes:</b> Not active when WYE NEUTRAL CON is programmed. When TPS is in ZERO CROSSING mode of operation, the calculated current used for this function is the ON state current value.
FREQUENCY 50 Hz		Display measured system frequency.
POWER 0 KW		Display measured system power.
LOAD CURRENT 0 % OF FLA		Display measured current as a ratio of LOAD RATED CURRENT (FLA).
UNBALANCE CURR. 0 %		Display unbalance current as a ratio of .

7.7.8 **Statistical data – page 10**

<b>STATISTICAL DATA</b> - **** -	
<b>Display and default values</b>	<b>Description</b>
TOTAL RUN TIME 0 HOURS	Displays TOTAL RUN TIME of the TPS since last statistics reset..
TOTAL # OF TRIPS 0	Displays TOTAL # OF TRIPS since last statistics reset.
TOTAL ENERGY 0 KWH	Displays TOTAL ENERGY drawn by the TPS in KWH since last statistics reset.

7.7.9 **Fault data – page 11**

<b>FAULT DATA</b> - **** -	
<b>Display and default values</b>	<b>Description</b>
LAST TRIP NO DATA	Displays TPS LAST TRIP cause.
LAST ALARM NO DATA	Displays TPS LAST ALARM cause.
TRIP I1 I2 I3 0 0 0 A	Displays TPS I1, I2, I3 when LAST TRIP occurred.
TRIP GND CURRENT 0 AMP.	Displays TPS calculated GND CURRENT when LAST TRIP occurred.
TRIP Vp1 Vp2 Vp3 0 0 0 V	Displays TPS MEASURED PHASE VOLTAGE when LAST TRIP occurred.
LAST 10 TRIPS: NO DATA	Displays TPS last trips.
PREVIOUS TRIP -2 NO DATA	
.	
.	
.	
.	
.	
.	
PREVIOUS TRIP -9 NO DATA	

## 8. TROUBLE SHOOTING

Upon fault – load stops, *Fault* LED lights and Fault Relay operates (as programmed). The LCD shows TRIP: and fault description. (for example: TRIP: UNDER CURRENT).

Fault Message	Cause and trouble shooting
UNDER CURRENT	<p>Trips/Alarms if UNDER CURRENT conditions exist.</p> <p><i>For more information on adjusting UNDER CURRENT refer to section 7.7.5 on page 29</i></p>
OVER CURRENT	<p>Trips/Alarms if TPS if UNDER CURRENT conditions exist.</p> <p><i>For more information on adjusting OVER CURRENT refer to section 7.7.5 on page 29</i></p>
UNBALANCE LVL 1, UNBALANCE LVL 2	<p>Trips/Alarms if UNBLANCE LEVELS exist.</p> <p><i>This alarm can be used when symmetrical load is connected to alert faulty elements. In case of an a-symmetrical load disable this protection.</i></p> <p><i>Check load for faulty elements.</i></p> <p><i>For more information on adjusting UNBALANCE LVLs refer to section 7.7.5 on page 29</i></p>
UNDER VOLTAGE, OVER VOLTAGE	<p>Trips/Alarms if UNDER/OVER VOLTAGE conditions exist.</p> <p><i>For more information on adjusting UNDER/OVER VOLTAGE levels refer to section 7.7.5 on page 29</i></p>
PHASE LOSS	<p>Trips/Alarms when one phase is missing. When two/three phases are missing the UNDER VOLTAGE alarm will show.</p> <p><i>Check connections to TPS.</i></p>
GROUND FAULT	<p>Trips/Alarms when line currents measured are not summed to zero. This alarm does not function when using WYE NEUTRAL CONNECTED.</p> <p><i>Check load for ground fault.</i></p> <p><b>Note:</b> <i>This alarm is very sensitive. Disable this protection in case of consecutive nuisance alarms.</i></p>
UNDER POWER	<p>Trips/Alarms when power derived from mains is lower then power programmed to TPS.</p> <p><i>This alarm can be used when an a-symmetrical load is connected to alert faulty elements.</i></p> <p><i>Check load for faulty elements.</i></p>

Fault Message	Cause and trouble shooting
SHORTED SCR	<p>Trips/Alarms when internal Thyristor is shorted.</p> <p><i>Consult factory.</i></p>
WRONG CONCT TYPE	<p>Trips/Alarms when TPS microprocessor sees a different connection type then the one programmed.</p> <p><i>Check actual connection type and programmed connection type. For more information on programming CONNECTION TYPE refer to section 7.7.1 on page 25.</i></p>
HEATSINK OVER T.	<p>Trips/Alarms when TPS thyristor heat sinks are over heated.</p> <p>Stop the unit and check for overload conditions and check right operation of fans.</p>
EXTERNAL FAULT	<p>Trips/Alarms when TPS gets an external input indicating a fault.</p>
COMM PORT FAILED	<p>Trips/Alarms when communication error occurs.</p> <p><i>Check wiring, Reset the TPS and try again. If this failure happands again consult factory.</i></p>
INTERNAL FAILURE	<p>Trips/Alarms when an internal failure is detected by the microprocessor.</p> <p><i>Get factory defaults and reprogram the TPS. For more information on getting factory defaults and reprogramming the TPS refer to section 7.5.1 on page 21.</i></p>
No control via Analog Input	<p>When the TPS is programmed to get its analog input via communication, wired analog inputs (Terminals 16, 17 and 20) are not operative.</p> <p><i>Refer to COMM. PARAMETERS SETTINGS – SER. LINK CONTROL. For more information on setting the right parameters for the TPS operation regarding SERIAL LINK CONTROL, refer to section 7.7.6on page 33.</i></p>
Output voltage/current does not go to zero even though analog input is lowest.	<p>Output voltage/current does not go to zero even though analog input is lowest.</p> <p><i>When load is connected in <u>WYE NEUTRAL NOT CONNECTED</u> or in <u>LINE DELTA</u> (both connections are without a neutral point) <b>and</b> TPS is in <u>PHASE CONTROL</u> it is impossible to go to zero output. Minimum possible firing for such case gives 10-20% of output voltage. This is since in this case the firing of each phase depends on the three phases mains and we cannot control each phase voltage down to zero. In this case, zero input in analog input causes the minimum possible voltage to appear in the output. Then, upon increasing the analog input voltage, output voltage/current is monotonically increased.</i></p>

8.1 **Warranty Claim and Fault Inquiry**

Representative Name:	Country:	Fax Number:	
Model Number And Build Options:	Example: 170 – 400 – 230 – 3M + 8 + L – S TPS _ _ _ - _ _ - _ _ + _ + _ - _		
Serial Number:			
Purchasing Date:			
Sale / Installation Date:			
Failure Date:			
Program Version: TPS- _ _ _ _ _	Press MODE + ▽, press SELECT twice, the LCD displays the program version (e.g. TPS-150802)		
Details of Fault / Fault Message:			
23			
Statistical Information		TPS Operative Information	
LAST TRIP:		TPS RATED CURRENT:	
LAST ALARM:		LOAD RATED CURRENT:	
TRIP I1 I2 I3			
TRIP GND CURRENT:			
TRIP Vp1 Vp2 Vp3:			
LAST 10 TRIPS:			
PREVIOUS TRIP -2:			

## 9. TECHNICAL SPECIFICATIONS

### 1. General

1.1	Rated Current	8-1500
1.2	Rated voltage	120 - 690VAC +10% -15% (of rated voltage)
1.3	Auxiliary voltage	120 or 230VAC, 110VDC+10% -15% (to be specified in order)
1.4	Frequency	50 / 60 Hz
1.4	Duty	Continuous
1.5	Controlled phases	Three
1.6	Enclosure	IP00
1.7	Ambient. Temp.	-10 – + 50°C (operating), -20 – + 70°C (storage)
	Altitude	To 1000 m ASL W/O de-rating
1.8	Cooling	Forced air (fans)
1.9	Number of CT's	Three
1.11	Connection modes	Wye - Neutral connected / not connected Line Delta, Inside delta, number of parallel branches each connection type

### 2. Control

2.1	Control method	-Digital
2.2	Firing method	-Zero crossing, Phase control, Phase control-power
2.3	On-Off time cycle	-1000 – 10000 mSec. (Programmable)
2.4	Analog input	-Floating inputs 0-10V >100K $\Omega$ / 4-20 mA, 0-20mA <100 $\Omega$ , Potentiometer input (programmable +int. jumper ) with programmable time constant exponential response.
2.5	Control inputs	- Start/Stop (with internal 0-60 sec time delays),Aux. contact (Programmable)
2.6	Output Relays	- 3 programmable (1-C/O) (8A/250VAC)
2.7	Synchronization (optional)-	One master and 2-9 connected slaves

### 3. Main, Protection & I/O parameters (see parameters settings)

#### 4. LEDs

Power ON (Green)  
Stop (Red)  
Run (Green)  
Alarm (Yellow)  
Trip (Red)  
Sync. (Green)

#### 5. LCD Display

5.1 Local on front panel, 2 lines 16 characters each.

### 7. Communication - RS-485 (Optional)

#### 8. Fan and TPS Consumption Ratings:

TPS 8-31A -	40VA
TPS 44-105A -	70VA
TPS 145-460A -	100VA
TPS 580-820A -	150VA



**Solcon Industries Ltd.**

[www.solcon.com](http://www.solcon.com) Technical support: [office@solcon.com](mailto:office@solcon.com)

## 10. ORDERING INFORMATION

<b>TPS</b>	<b><u>31-</u></b>	<b><u>400-</u></b>	<b><u>230-</u></b>	<b><u>230-</u></b>	<b><u>0-</u></b>	<b><u>S</u></b>
	<b>Full load Current</b>	<b>Mains Voltage</b>	<b>Control Voltage</b>	<b>Control inputs Voltage</b>	<b>Options</b>	<b>Front Panel</b>

**Full load Current**

Specify	Description
TPS RATED CURRENT [A]	8, 17, 31, 44, 58, 72, 85, 105, 145, 170, 210, 310, 390, 460, 580, 820, 950, 1100, 1500

**Mains Voltage**

Specify	Description
400	230 – 400 VAC, +10% -15%, 50/60Hz
480	480 VAC, +10% -15%, 50/60Hz
600	600 VAC, +10% -15%, 50/60Hz
690	690 VAC, +10% -15%, 50/60Hz

**Control Voltage**

Specify	Description
115	115 VAC, 50/60Hz, +10% -15%
230	230 VAC, 50/60Hz, +10% -15%
110 VDC	110 VDC <sup>(1)</sup>
<b>Notes:</b>	<ul style="list-style-type: none"> <li><sup>(1)</sup> For DC control voltage or control inputs voltage - consult factory.</li> </ul>

**Control inputs voltage**

Specify	Description
115 <u>or</u> 230	90 – 230 VAC, 50/60Hz or 90 – 230 VDC
24	24VAC, 50/60Hz or 24VDC <sup>(1)</sup>
48	48VAC, 50/60Hz or 48VDC <sup>(1)</sup>
<b>Notes:</b>	<ul style="list-style-type: none"> <li><sup>(1)</sup> For DC control voltage or control inputs voltage - consult factory.</li> </ul>

**Options**

Specify	Description
0	No options
3M	Communication RS-485 (MODBUS) <sup>(1)</sup>
5	Analogue card <sup>(3), (1)</sup>
8	Harsh environment treatment <sup>(1)</sup>
D	Remote panel mounting replacing the original panel. (Supplied with 1.5 m cable). <sup>(1), (2)</sup>
Sync.	Synchronization between up to 9 TPS units. <sup>(1)</sup>
P	Potentiometer control. (No need for external power source) <sup>(1)</sup>
<b>Notes:</b>	<p>For more than one option indicate, for example: 8+5 (Harsh environment and analogue card)</p> <p><sup>(1)</sup> Must be ordered in factory – can not be installed on site.</p> <p><sup>(2)</sup> D option is available for TPS 145A and up.</p> <p><sup>(3)</sup> Analog out optional PCB is available from TPS-145A and up.</p>

**Front Panel**

Specify	Description
S	Standard

**Example:**

TPS rated 820A, mains voltage - 230V, control voltage- 230VAC, control inputs- 48VDC Modbus communication card, Harsh environment treatment, Synchronized TPS and standard front panel: **TPS 820 - 230 – 230 - 48 - 3M+8+SYNC – S**